

# REC Wi-Fi MODULE



 **REC**  
*Control your power!*

Novi trg 9, 6230 Postojna, Slovenia  
mail: [info@rec-bms.com](mailto:info@rec-bms.com); [www.rec-bms.com](http://www.rec-bms.com)

All information in this document is subject to copyright and other intellectual property rights of REC d.o.o. and its licensors. The material may not be modified, reproduced, or copied, in whole or in part without the prior written permission of REC d.o.o. or its licensors. REC d.o.o., 2022.

## Features

- Completely replaces PC user interface and adds several new features.
- Stand-alone operation mode (STA) for all smart Wi-Fi devices and Access point (AP) allowing a variety of network configurations.
- 10-68 V power supply, 450 mW - STA mode, 800 mW - AP mode
- Allows Wi-Fi and BMS firmware updates all through a single browser interface.
- Default, ESS, and Manual settings can be changed.
- Includes 16 GB Micro SD card for data logging and log analyzer.
- Remote DC switch 100 V, 3 A DC gives you the ability to remotely control additional devices such as security lightning, remote generator start, ...
- Includes a cable that allows simultaneous use of REC LCD touch display.
- Includes both MAIN connection and LCD connection adapter cable harnesses.
- The Wi-Fi module has been designed to minimize its parasitic load, with features such as deep sleep that reduces its power demand.
- Connect by using any modern browser, such as Safari, Chrome, Edge, Firefox, ...
- Only one Wi-Fi module is required in BMS configurations with more than one BMS (in parallel or serial connections) on your RS485 network.

## INDEX

Features .....	1
Description .....	3
Hardware Parameters: .....	4
Default Software Parameters: .....	6
Wi-Fi Module Connections.....	7
Connection Setup.....	8
Setup.....	8
Setting the device to access point (AP mode) .....	8
Connecting the device to an existing network (STA mode) .....	8
Default settings.....	9
Functionality .....	10
Home tab .....	11
Tasks tab .....	12
Voltage tab .....	13
Impedance tab.....	13
Temperature tab.....	13
Settings tab.....	14
Logs tab.....	17
Firmware tab .....	18
REC LCD Touch Display Connection.....	22
Remote DC Switch.....	22
Power Saving Mode .....	23
Enclosure Dimensions.....	23
Wiring Harness.....	23

## Description

REC Wi-Fi module is an additional device that connects to REC BMS devices via RS-485 and connects to an existing network or sets up its own one to enable both: the configuration and monitoring capabilities of your battery pack. Parameters such as cell voltages, current, temperatures, state of charge and state of health are all easily displayed and trended. The interface includes several tabs to ensure ease of use:

**General tab - HOME** is used to display important parameters while dedicated tabs can be used to display advanced battery pack information. An **alarm pop-up** sign informs the user in case of any system error or alarm, containing its diagnostics.

**SETTINGS tab** enables the user to configure all the voltage, current and system settings for the battery pack including ESS settings. In addition, all the settings of the BMS may be exported to a file and imported back as your default settings or for a purpose application.

**LOGGING tab** enables logging interval setting, importing logs and log analyzer. Logs are saved to an internal 16 Gb micro-SD memory card and may be easily transferred to any connected device for further analysis.

Additionally, the REC Wi-Fi module enables to remotely activate a DC switch. A galvanically isolated fused opto-relay is used to power the loads up to 100 VDC, 3 A. This function is easily controlled from a single pushbutton on your main screen.

## Hardware Parameters:

**Table 1:** BMS hardware parameters.

PARAMETER	VALUE	UNIT
Supply voltage	10.0 – 68.0	V
Under-voltage protection	9.8	V
Supply current standby @		
Supply voltage 12 V	3.4	mA
Supply voltage 24 V	1.8	mA
Supply voltage 48 V	1.5	mA
Supply voltage 60 V	1.4	mA
Supply current AP mode @		
Supply voltage 12 V	62.6	mA
Supply voltage 24 V	30.9	mA
Supply voltage 48 V	16.2	mA
Supply voltage 60 V	13.4	mA
Supply current STA mode @		
Supply voltage 12 V	32.7	mA
Supply voltage 24 V	16.5	mA
Supply voltage 48 V	8.9	mA
Supply voltage 60 V	7.4	mA
Max DC voltage @ opto - relay	100	V
Max DC current @ opto - relay	3.0	A
Max opto – relay delay off -> on	5.0	ms
Max opto – relay delay on -> off	1.0	ms
Max opto – relay reverse voltage	-0.4	V
Internal SD card size Class 10	16	GB
Internal opto-relay fuse	3.15 slow blow	A
MAIN connector adapter harness length	0.5	m
LCD connector adapter harness length	0.5	m
Enclosure dimensions (w × l × h)	127 x 70.6 x 35.5	mm
Mounting screws max diameter	3.5	mm
Weight	117	g
Enclosure material	ABS plastic	n.a.
Enclosure type manufacturer/number	Takachi/TWF7-11-4D	n.a.
IP protection	IP32	n.a.
HW version	2.0	n.a.

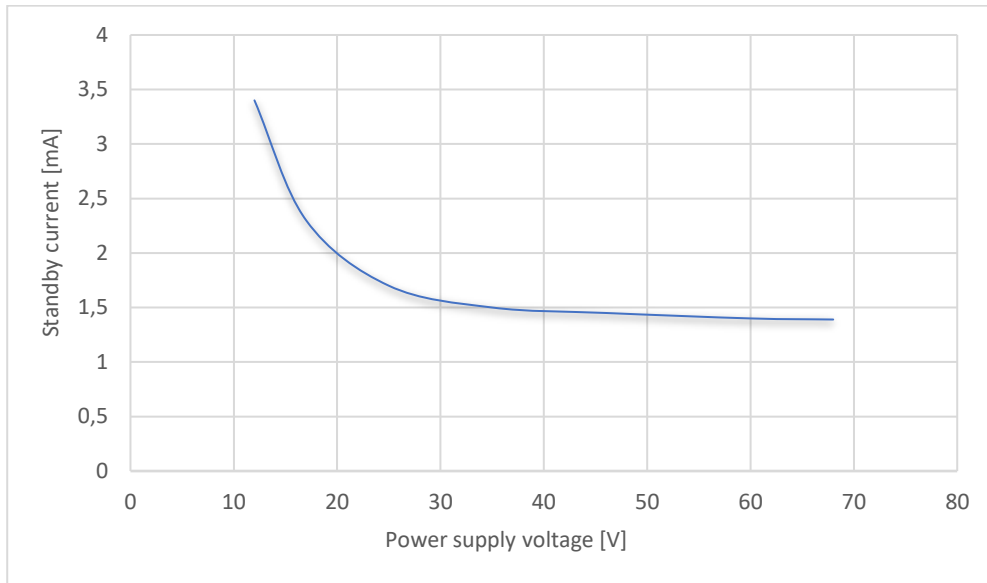

**Figure 1:** Wi-Fi module standby supply current.

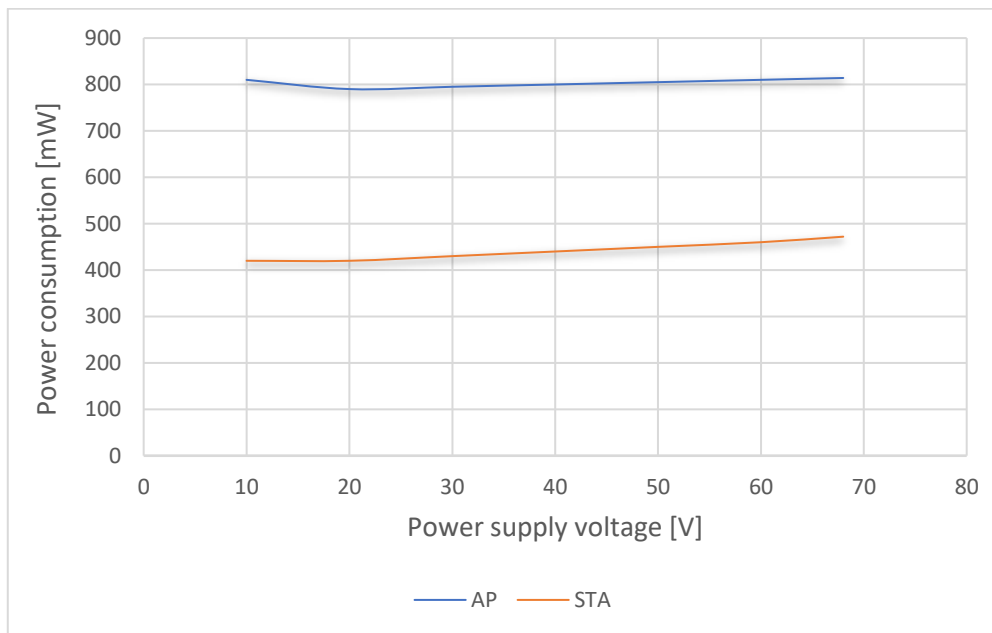

**Figure 2:** Wi-Fi module power consumption for both connection modes.

## Default Software Parameters:

**Table 2:** Default Wi-Fi module parameter settings.

PARAMETER	VALUE	UNIT
IP address	192.168.1.184	n.a.
Wi-Fi SSID	REC_BMS	n.a.
Wi-Fi password	none	n.a.
Wi-Fi module connection mode	Access point (AP)	n.a.
BMS RS-485 send address	16	n.a.
Wi-Fi module RS-485 receive address	0	n.a.
BMS RS-485 bitrate	56	kbit
LCD RS-485 bitrate	56	kbit
Logging interval	600	s
Temperature units	-	°C
SW version	1.61	n.a.

## Wi-Fi Module Connections

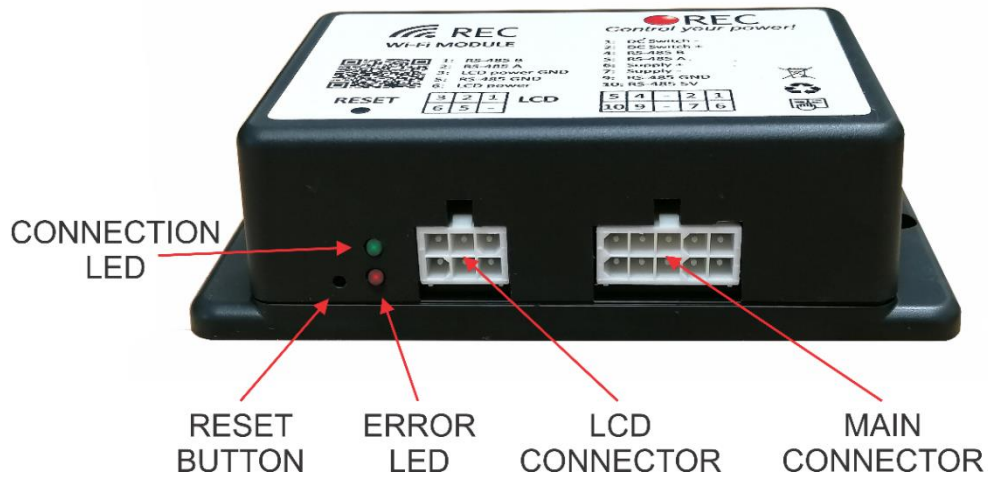

Figure 3: Wi-Fi module connections.

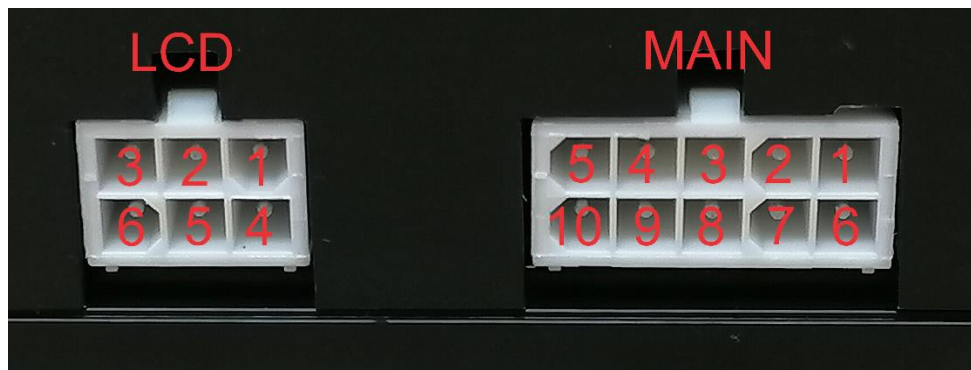

Figure 4: Wi-Fi module connector description.

HW version 1.2 uses internal LED indicators for ERROR and CONNECTION.

Table 2: MAIN Connector pinout table.

MAIN CONNECTOR PIN	DESIGNATOR
1	DC Switch –
2	DC Switch +
3	N/C
4	RS-485 - B
5	RS-485 - A
6	Power supply +
7	Power supply GND
8	N/C
9	RS-485 – GND
10	RS-485 – 3.3V



**Table 3:** LCD connector pinout table.

LCD CONNECTOR PIN	DESIGNATOR
1	RS-485 LCD - A
2	RS-485 LCD - B
3	N/C
4	N/C
5	RS-485 LCD – GND
6	N/C

## Connection Setup

### Setup

1. Connect the module to the REC BMS via RS-485 connection using included harness.
2. Connect the power supply to the REC Wi-Fi module. See Table 1 for power supply restrictions.
3. If connecting the module for the first time, the device will set up an access point, with default credentials (SSID: REC\_BMS, PASS: *none*). If this does not happen, please reset the device by holding factory reset button for 20 s.
4. Using a Wi-Fi supported device, connect to the access point REC-BMS\_AP.
5. Open your browser and go to IP address 192.168.1.184 by typing it on your browser's top line. If successful it will open the Main Menu. You should now see your battery pack status. If the "REC BMS not found" is shown, then you will need to set up your communication parameters. Remember that your Wi-Fi module can connect to any REC BMS connected to your RS485 network. Select the **Firmware tab** from the Main menu and set your **Send and Receive** addresses in Communication Settings to match the connected REC BMS device (1Q BMS has a default RS-485 address of 1, ABMS address 2 and 9M Master BMS address 16).

The Wi-Fi module can be configured for direct access (AP) or integrated into your home network (STA). To access it remotely it will need to be integrated into your home network as an STA device and port forwarding set up. This is configured within your home router and is not covered here as each manufacturer handles it differently.

### Setting the device to access point (AP mode)

1. Connect to the Wi-Fi device.
2. Select the **Firmware tab** from the Main menu.
3. Change the **Wi-Fi name** and **Wi-Fi password** (up to 50 ASCII signs for both) to desired credentials and confirm with **Submit** button.
4. Device will restart and set up the new access point.

### Connecting the device to an existing network (STA mode)

1. Connect to the Wi-Fi device.
2. Select the **Firmware tab** from the Main menu.
3. Change the **Wi-Fi name** and **Wi-Fi password** (up to 50 ASCII signs for both) of the desired network and confirm with **Submit** button.
4. If existing network is not found it will revert an access point with set credentials, so you maintain your link and can try again.
5. If the Wi-Fi module finds and connects to the existing network access point Wi-Fi

network will now be established and you can log in to it when you reconnect to your home network. If you need to reconfigure it again locally, simply press the **Reset** button to reset it back to default (AP) settings.

After the first connection check for the [latest update](#) and upload it to the Wifi module.  
[Video instructions.](#)

### Default settings

By pressing the factory **Reset** button and hold it for 20 s, all device settings will be reset to default.

**Table 4:** Wi-Fi module default settings.

Wi-Fi MODULE SETTING	DEFAULT VALUE
Wi-Fi SSID	REC_BMS
Wi-Fi password	<i>none</i>
IP	192.168.1.184
Send address	16
Receive address	0
Log interval	10 min

## Functionality

A list of tabs may be selected from the Main menu shown on the left side of the screen. User may choose between **Home** tab, **Tasks**, **Voltage**, **Impedance**, **Temperature**, **Settings**, **Logs** and **Firmware** tab.

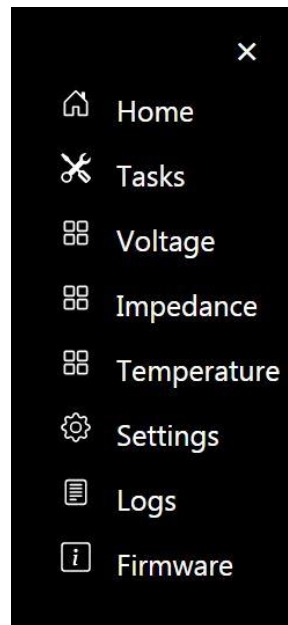





**Figure 5:** Main menu tab selection.

## Home tab

Battery pack main parameters are shown in the **Home** tab. BMS serial number is shown on top, while the battery pack main parameters are shown below. State of charge (SOH) is shown as a graphical color bar and as a number in % as well. The color of the bar changes regarding the battery SOC state.

**Table 5:** Battery pack SOC bar colors.

SOC RANGE [%]	SOC BAR COLOR [RGB]	SOC BAR APPERANCE
0-10	240 59 39	
10-30	228 133 46	
30-50	194 216 53	
50-90	155 201 75	
90-100	74 169 79	

Battery pack capacity in Ah is shown as total operational capacity (SOH x nominal capacity) and used capacity (0 @ SOC = 100%). Total battery pack voltage and current are shown as well as its power in W. Home tab also displays maximum and minimum cell voltage and maximum battery pack temperature. State of health (SOH) is displayed under the SOC in %. See Fig. 6

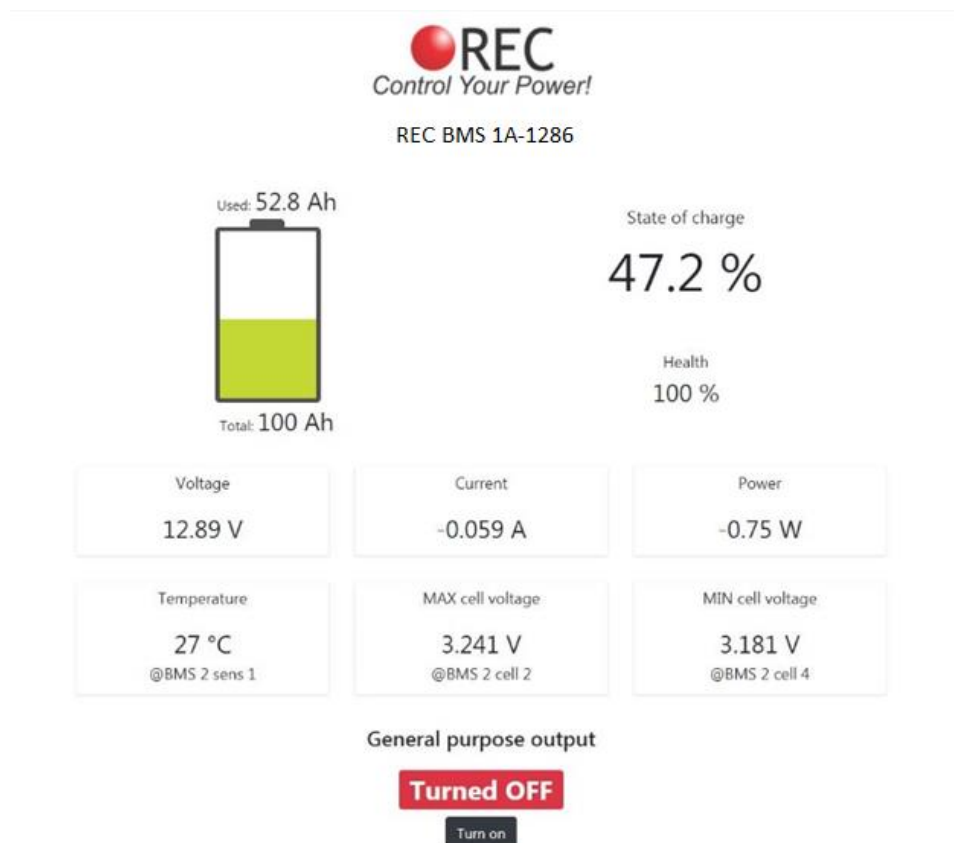

**Figure 6:** Home screen tab.

Numbers near the maximum, minimum cell and maximum temperature describe their location in the battery pack.

In case an error is present, an exclamation triangle appears in the middle of the battery icon. User may press the sign for additional error description.

If connected to a unit that supports IO tasks, state of all outputs is also displayed. General-purpose output indicates the state of integrated DC switch with galvanically isolated opto relay. OFF indicates the relay is open and ON the opto-relay is closed. You can change its state by pressing **Turn on/Turn off** button.

### Tasks tab

This tab is designed for ABMS firmware update and future REC products. ABMS will be the first one to incorporate this feature, then REC BMS 2Q 4-16S successor of the REC BMS 1Q and the last new Master BMU.

Each BMS output that supports task option may be programmed individually. Automatically controls the devices outputs. A battery pack parameter may be selected (cell voltage, temperature, SOC) and a compare value with hysteresis should be set. Positive or negative logic may be selected for the output. Additionally, an output may be controlled also with all system errors. Error number is easily selected by ticking the check box next to the error number.

**Table 6:** Output logic description.

OUTPUT LOGIC	OUTPUT STATE WITHOUT ERROR	OUTPUT STATE WITH ERROR
Negative with ERROR off	OFF if value higher than compare value, ON if lower	OFF
Positive with ERROR off	ON if value higher than compare value, OFF if lower	OFF

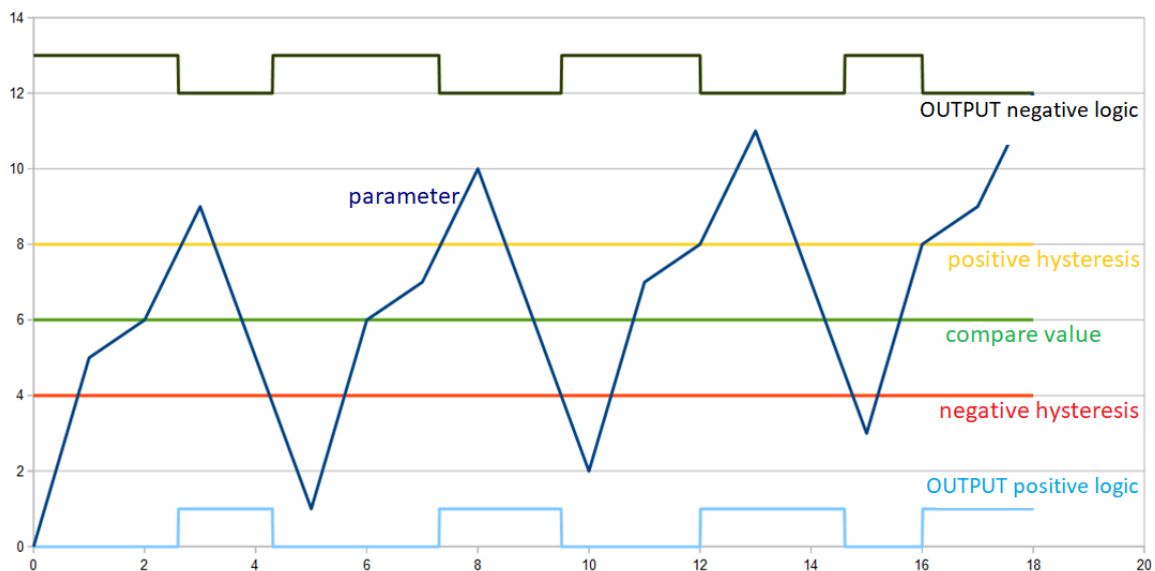

**Figure 7:** Output logic description.

## Voltage tab

All of the battery pack cell's voltages are displayed. If Master BMS unit is used, cells are displayed in sequentially groups as BMS 1, BMS 2, BMS 3, ... In case one of the cell's voltage is too high or too low regarding the BMS cell voltage setting, the value is highlighted in red color.



BMS 1	
Cell	Cell voltage
1	3.231 V
2	3.241 V
3	3.237 V
4	3.181 V

**Figure 8:** Cells voltages.

## Impedance tab

All of the battery pack cell's DC impedance values are displayed. If Master BMS unit is used, cells are displayed in sequentially groups as BMS 1, BMS 2, BMS 3, ...



BMS 1	
Cell	Cell resistance
1	2 mΩ
2	2 mΩ
3	2 mΩ
4	2 mΩ

**Figure 9:** Cells' impedance.

## Temperature tab

All of the BMS temperature sensors values are displayed in this tab. On top BMS internal temperature is shown, then a list of digital DS18B20 cell temperature sensors' values are shown. If master BMS unit is used, cells are displayed in sequentially groups as BMS 1, BMS 2, BMS 3, ... If one of the temperature sensor's temperature is too high, it is highlighted in red.

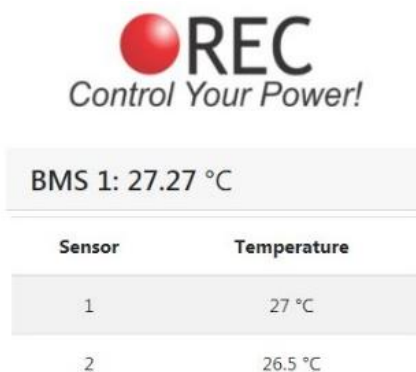

**Figure 10:** BMS and Cells' temperatures.

## Settings tab

**Settings tab** enables the user to change most important BMS settings. A **Manual communication** input windows in the **Firmware tab** enable the user to observe and set non-listed settings. Four letter setting instructions are used as described in the BMS unit manual, chapter RS-485 instruction description.

**Table 7:** Parameter/setting description.

PARAMETER	DESCRIPTION
<b>Voltage settings</b>	
Balancing voltage END	Sets the balancing voltage above which the individual cell is balanced 100 %.
Balancing START voltage	Sets the average open circuit battery pack's voltage above which the BMS performs the balancing while charging. Special balancing algorithm is used to determine which cells have to be balanced until the Balance Voltage END is reached.
END of charging	Sets the end of charge voltage of the individual cell.
END of charging voltage hysteresis per cell	Sets the end of charging hysteresis of the individual cell.
Maximum allowed cell voltage	Max allowed cell voltage.
Minimum allowed cell voltage	Min allowed cell voltage.
Maximum allowed cell voltage hysteresis	Max allowed cell voltage hysteresis.
Minimum allowed cell voltage hysteresis	Min allowed cell voltage hysteresis.
Minimum cell discharge	Minimum cell voltage for the ESS. Should be 0.12- 0.2 V per cell higher than Min allowed cell voltage

<b>Current settings</b>	
Shunt	Select the current used in the drop menu or use current sensor coefficient if the used shunt is not listed.
Current sensor coefficient	Current sensor's coefficient can be changed when changing the current sensor's value.
Current sensor offset	Current offset compensation.
Maximum inverter device charging current	Limit inverter device's charging current.
Maximum inverter device discharge current	Limit inverter device's discharging current.
Charging coefficient	Charging coefficient for max charging battery current calculation
Discharging coefficient	Discharging coefficient for max charging battery current calculation
<b>Temperature settings</b>	
Units	Displayed temperature unit is imperial in °F or metric in °C
Maximum allowed cell temperature	Battery pack is disconnected from the system, if the $T_{BAT}$ temperature is higher than the $MAX T_{BAT}$ . $MAX T_{BAT}$ hysteresis is set to 2 °C/K.
Maximum allowed BMS temperature	Sets the maximum allowed temperature of the BMS – $T_{BMS}$ due to the passive balancing in REC Q BMS. The balancing is stopped until the temperature drops under the set value.
Maximum allowed BMS temperature hysteresis	Sets the maximum allowed BMS temperature hysteresis.
Min allowed temperature for charging	Charging is not allowed under $T_{BAT}$ . $MIN T_{CHARGE}$ hysteresis is set to 2 °C/K.
<b>System settings</b>	
Operational capacity	Battery operational capacity (Single string), lower than nominal capacity since the cell limits are usually set more conservatively
Battery cycles	Number of effective battery cycles.
Chemistry	Select cell chemistry (Ideal LTO and Custom option may not be programmed into the BMS firmware – if set error 13 will alarm)
Number of inverter devices	Select the number of inverter devices in the system for current calculation

\* Please note that a decimal comma is used when entering parameter values.



### Voltage settings

Balance Voltage END [V]:	4.15
Balancing START voltage [V]:	4
END of Charging [V]:	4.15
END of charging voltage hysteresis per cell [V]:	0.1
Max allowed cell voltage [V]:	4.18
Min allowed cell voltage [V]:	3.2
Max allowed cell voltage hysteresis [V]:	0.03
Min allowed cell voltage hysteresis [V]:	0.1
Min Vcell discharge [V]:	3.35

**Figure 11:** BMS and ESS voltage settings.

### Current settings

Shunt	200A/50mV
Current sensor coefficient	0.007813
Current sensor offset [A]:	0
Max charging current per device [A]:	70
Max discharging current per device [A]:	100
Charging coefficient [C rating]:	0.6
Discharging coefficient [C rating]:	1.6

**Figure 12:** BMS and ESS current settings.

### Temperature settings

Units	°C
Maximum allowed cells temperature [°C]:	55
Max allowed BMS temperature [°C]:	55
Max allowed BMS temperature hysteresis [°C]	5

**Figure 13:** BMS temperatures settings.

### System settings

Operational capacity [Ah]:	320
Battery cycles	2
Chemistry:	LiMnO2
Number of inverter devices	2

**Figure 14:** System settings and settings import/export.

## Logs tab

REC Wi-Fi module logs all BMS data. User can select logging interval in steps from 5 s to 60 min. A log is created every day or when the maximum size of the log (set to 5 MB) is reached.

Logs can be viewed by clicking **VIEW** button or downloaded by clicking **DOWNLOAD** button. If you want to view a saved log that is no longer present on the device, click **Import external log** and choose the one you desire to view. If the BMS connected to the Wi-Fi module integrates Real time clock (RTC) a date and time is also displayed.

When viewing the log, select the parameter you want to display. In case of Master-Slave configuration, a Slave data may be displayed separately by choosing it in top right corner '**BMS selector**'. Single or multiple cells/temperatures may be displayed. Logs also display BMS errors in red color with an additional description.

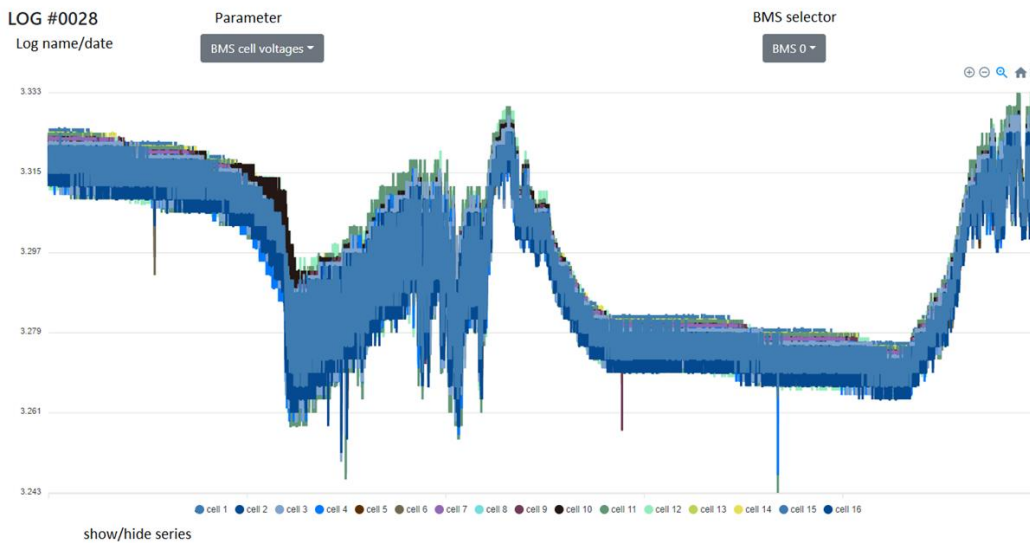

**Figure 15:** Battery pack cells voltage log.

## Firmware tab

**Firmware tab** is used for different purposes. User may unlock the settings, set the communication with the connected BMS device. A Wi-Fi module operational mode can be set here with all the required settings and an additional login can be added. This tab also displays the SD card information and BMS RTC if available. RTC data is available on the ABMS and Master BMS 9M. At the bottom of the tab Firmware update may be found for updating the Wi-Fi module or BMS device/s.

### Unlock communication

If settings/parameters of the REC BMS should be changed, the communication with the BMS must be established and unlocked. To unlock the settings, enter the BMS password that is its serial number without the first “-” e.g., 1A-1286.

### Unlock REC BMS unit communication

**Figure 16:** Unlock communication window.

### BMS info

This part of the **Firmware tab** describes the BMS device connected to the Wi-Fi module. Software and Hardware versions are displayed, so the user knows if the firmware update is required. BMS name is set as its serial number also used for unlocking the communication.

### BMS info

Software version:	2.7
Hardware version:	2.1
BMS name:	1A-1286

**Figure 17:** BMS device information.

### Communication settings

These settings are used to send/receive the data to the connected REC BMS using galvanically isolated RS-485 communication.

#### Send address:

1. REC BMS 1Q unit has a default address of 1 (change if set differently on the BMS device),
2. REC Active BMS unit has a default address of 2 (change if set differently on the BMS device) and
3. REC BMS Master unit, set the Send address to 16.

#### Receive address:

1. Always set to 0, except when
2. using Master-Slave configuration to communicate with the Slaves units: set **Send address** of the connected BMS slave unit and set the **Receive address** to 16.

### Communication settings

Select baudrate:	56000 ▾
Select LCD baudrate:	56000 ▾
Send address:	1
Receive address	0
<input type="button" value="Set"/>	

**Figure 18:** Communication settings window.

### Wi-Fi settings

Information about the wireless network is displayed. **Wi-Fi mode** indicates if the device is working in **AP** mode or **STA** mode. Devices MAC and signal strength are displayed, along with IP address, which can be changed if using multiple devices or if IP is already taken. Once the device is connected in the **STA** to designated Wi-Fi network it is not seen as an AP device with its own network. To see it back to AP mode a Reset button should be used or an access through the existing network should be used to connect to the Wi-Fi module and set it back to the AP mode.

### Wi-Fi settings

Wi-Fi mode:	Access point	Existing WiFi selection:
		Scan for networks first. ▾
Wi-Fi MAC:	94:3C:C6:4B:BF:B8	Scan
Signal strength	0 dB	Wi-Fi name(ASCII characters only):
		REC-BMS_AP
Local IP	192.168.1.184	Wi-Fi password(ASCII characters only):
Gateway	192.168.1.1	
Subnet	255.255.0.0	Submit
	Set	

Figure 19: Wi-Fi connection settings.

Read more about **Setting the device to AP** and **Connecting the device to an STA** in the chapters below.

### Login page settings

Additional login credentials, which provide another layer of safety, can be set to lock the access to the device. This is useful if connected to a Wi-Fi network with multiple users or if using tunneling to a local host.

### Login page settings

Enable page	Login name:	Login password:	
Disabled ▾	admin		Set

Figure 20: Additional login page settings window.

### SD memory card info

Information about internal SD memory card is displayed. A 16 GB, class 10 SD card is usually used in the module. Some of the SD card memory is reserved for other purposes. If the size of the saved logs exceeds the space required for logging, the oldest log will be deleted (FIFO). In case of SD card problems, unplug the Wi-Fi module wiring, disabling its operation. Open the module and take the SD card out of the slot by sliding the slot sideways. Inspect card and slot contacts - there is a possibility of oxidation in the rush environment. Put the card back in the card slot, secure the slot and reverse the rest of the procedure. If this does not help, download card data to a computer, format the card and put it back in.

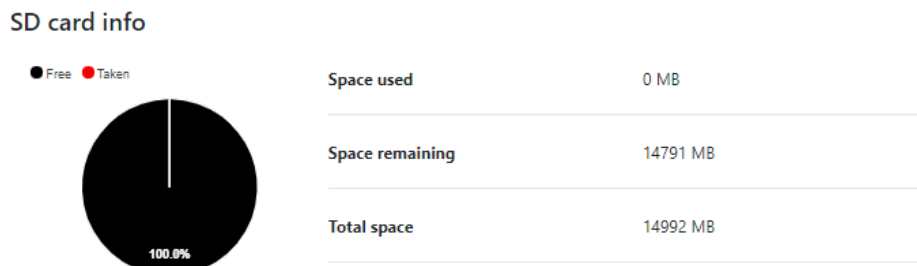

Figure 21: SD card information.

### Firmware update

Both BMS unit and Wi-Fi unit may be updated using Firmware update tool in the **Firmware** tab. Make sure that the hardware (HW) version matches the version of the update file.

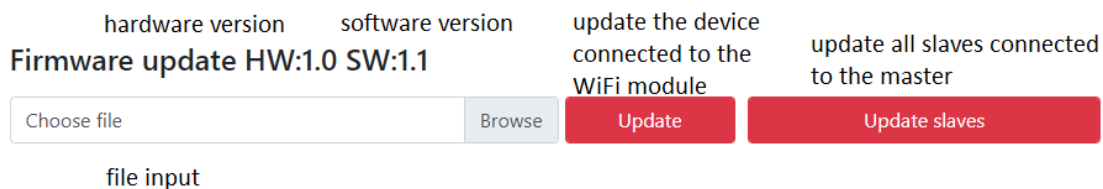

Figure 22: BMS firmware update window.

### Updating Wi-Fi module's firmware

1. Connect to the device.
2. Select **Firmware** tab from the menu and scroll to the bottom of the tab.
3. Check the HW version next to **Firmware update**.
4. Browse and select the **update.bin** file.
5. Press update. Wait until the process is finished.
6. Browse and select the **spiffs.bin** file and press update.
7. After the file was successfully uploaded, power reset the device. Allow few seconds to update from the SD card after power reset.

### Updating the firmware of the RS-485 connected BMS device

1. Connect to the device.
2. Select **Firmware** tab from the menu and scroll to the bottom of the tab.
3. Browse and select the BMS firmware file that has to start with bms\_.....bin
4. Press update.
5. Reset the BMS device by ON/OFF button to start the update in 60 s.
6. Wait until the firmware is fully loaded. BMS will restart automatically.

### Updating whole BMS Master-slave system's firmware

This is possible only with system of slave BMS connected to the REC BMU Master unit (not yet available).

1. Connect to the device.
2. Select **Firmware** tab from the menu and scroll to the bottom of the tab.
3. Choose the update file.
4. Click update slaves and follow displayed instructions.

[Video instructions.](#)

## REC LCD Touch Display Connection

Wi-Fi module may be used as a RS-485 buffer to transfer the BMS data to the LCD touch display. LCD connection adapter cable should be used between the Wi-Fi Module LCD connector and LCD connector. LCD will not find any connected BMS or its data if the Wi-Fi module is not connected to the BMS and receiving data. When the Wi-Fi module is performing time consuming tasks like SD card write/read, LCD display refresh rate is lowered. **LCD display may have different or the same power supply as the Wi-Fi module, but it is important to have the same ground potential (connect Wi-Fi module negative to LCD negative supply).** Wi-Fi module has its own RS-485 termination for the LCD port soldered on the PCB – R10, located next to the LCD port common mode choke. When connecting the LCD to the Wi-Fi module either Wi-Fi module termination on the Wi-Fi module should be unsoldered or LCD DB9 shell should be opened and 1k2 resistor should be unsoldered from the pins 3 and 4 on the inside of the DB9 female connector.

## Remote DC Switch

Wi-Fi module integrates a galvanically isolated opto-relay LCA701. Its dual output is connected in parallel to double the load current. This way it is limited to DC load control only. A bypass diode is used to enable use of inductive loads like relay coil. A time delay 3.15 A fuse is used to limit the load current. See Fig. YY for wiring schematics.

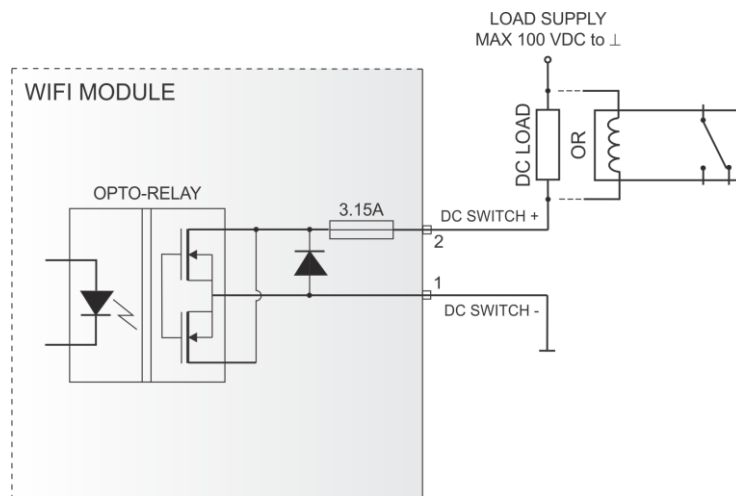

Figure 23: DC switch wiring.

Switch may be controlled by the **Turn on/Turn off** button @the bottom of the **Home** tab. An indicator is present displaying its state, OFF meaning, the switch is opened and ON meaning, the switch is closed. BMS device must be connected to the Wi-Fi module to enable this feature. See [Video instructions](#).

General purpose output

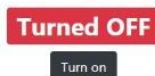

Figure 24: Remote DC switch button and status.

## Power Saving Mode

If a REC BMS device is not detected after an hour, the Wi-Fi module enters standby mode to reduce the power consumption. Every 2 hours it wakes up and check if a device present. Same principle applies when a low cell voltage is detected. To wake up device, turn it OFF and ON again manually by switching the power supply.

## Enclosure Dimensions

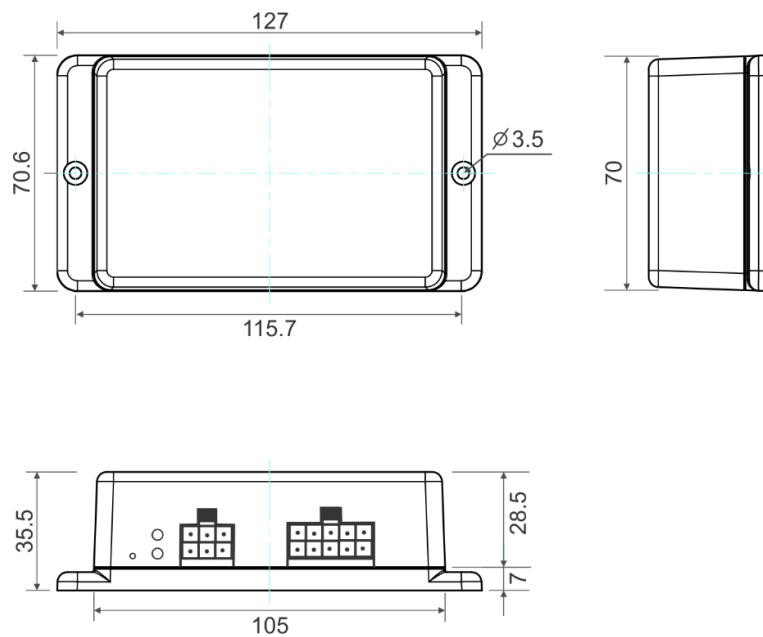

Figure 25: Wi-Fi module enclosure dimensions.

## Wiring Harness

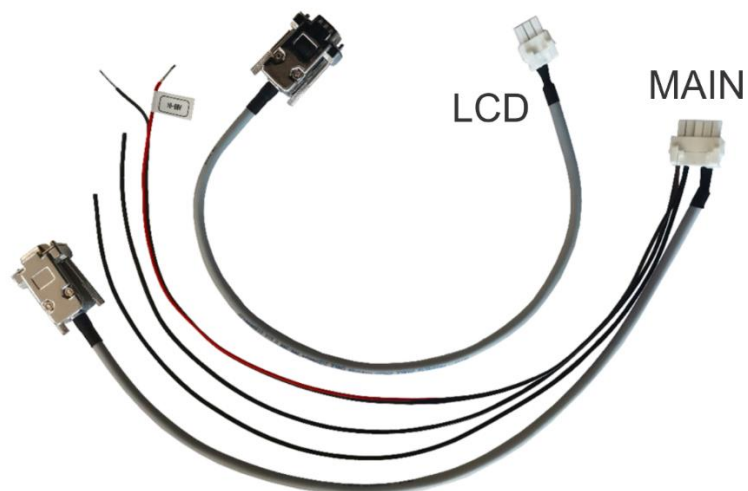

Figure 26: Wi-Fi module wiring harness.

Cable harness length is 0.5 m.